

Data sheet - BSO-3,5M3-14

Blind self-clinching standoffs

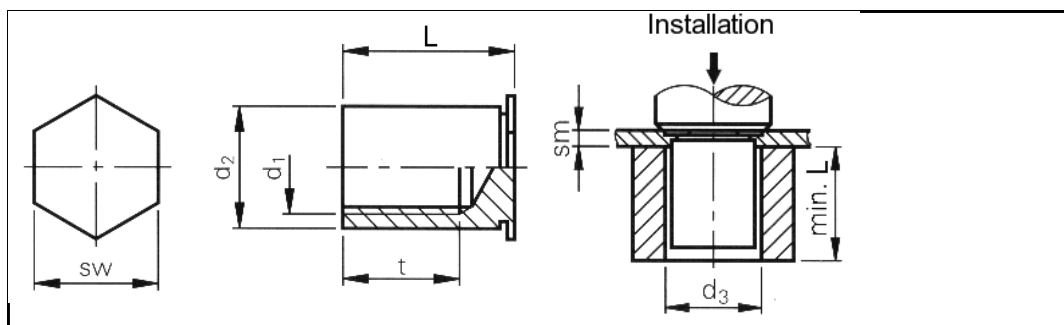

3D-Data available	
Order description	BSO-3,5M3-14
Thread d1	M3
Hole-Ø in the sheet +0.08 0	5.4 mm
d2 0 -0.13	5.39 mm
d3	5.6 mm
sw	6.4 mm
Min. sm	1.0 mm
L +0.05 -0.13	14 mm
Depth of thread tmin.	6.5 mm
Min. edge distance up to the hole centre	6.8 mm
Material	Case-hardened zinc-plated carbon steel, bright-finished aluminium on request.
Use	For sheet hardnesses up to HRB 80.
Note	For sheet applications > HRB 80, type BSO4 should be used.
Tools	
Insertion machines	

uniform resource locator: